

Variable Gain Sub Femto Ampere Current Amplifier

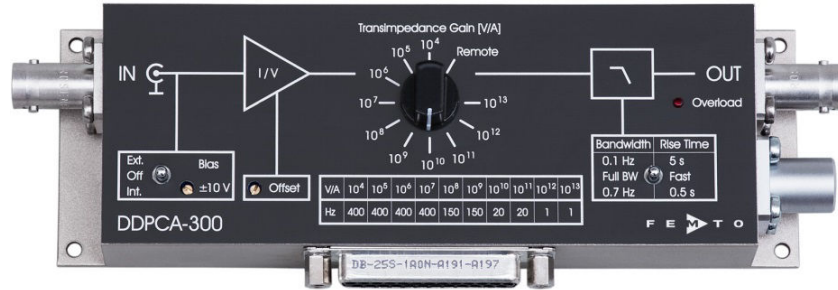

<p>Features</p>	<ul style="list-style-type: none"> • 0.4 fA peak-to-peak noise • Very high dynamic range: sub-fA to 1 mA (> 240 dB) • Transimpedance (gain) switchable from 1×10^4 to 1×10^{13} V/A • Bandwidth up to 400 Hz, rise time down to 0.8 ms - independent of source capacitance (up to 10 nF) • Adjustable bias voltage on input relative to ground • Compact housing for use close to the signal source • Local and remote control • Easy to use: Convert your standard digital voltmeter or DAQ board to a high-end digital sub femto amperemeter
<p>Applications</p>	<ul style="list-style-type: none"> • Photodetector amplifier • I/V characterization of small MOS structures • DC measurements of ultra-low currents • Ionization detectors, mass spectrometry, quantum and biotech experiments • characterization of high impedance nanomaterials • Spectroscopy • High resistance measurements
<p>Block Diagram</p>	

Variable Gain Sub Femto Ampere Current Amplifier

Specifications	Test conditions	$V_s = \pm 15\text{ V}$, $T_A = 25\text{ }^\circ\text{C}$, relative humidity < 50 % load impedance = 1 M Ω warm-up 20 minutes (min. 10 minutes recommended)				
Gain	Transimpedance	1 x 10 ⁴ ... 1 x 10 ¹³ V/A (load \geq 100 k Ω)				
	Gain accuracy	$\pm 1\%$				
	Gain drift	see table below				
Frequency Response	Lower cut-off frequency	DC				
	Upper cut-off frequency	up to 400 Hz (see table below)				
	Adjustable low pass filter	switchable to 3 settings (full bandwidth, 0.7 Hz and 0.1 Hz)				
		<u>Upper cut-off</u>	<u>Rise time</u>			
		Full BW (see table below)		Fast (see table below)		
		0.7 Hz	0.5 s			
		0.1 Hz	5 s			
		Setting the low pass filter to full bandwidth is recommended for high measurement speed. By setting the low pass filter to 0.7 Hz or 0.1 Hz the peak-to-peak noise performance can be improved but the signal settling time will be longer.				
Input	Equ. input noise current	gain setting dependent, see table below minimum input noise is 0.4 fA peak-peak (at gain setting 10 ¹² or 10 ¹³ V/A with low pass filter switched to 0.1 Hz)				
	Input bias current	20 fA typ. / 30 fA max.				
	Input bias current drift	factor 2 / 10 $^\circ\text{C}$				
	Max. input current (full scale)	see table below (value for linear amplification)				
	Input offset compensation	adjustable by offset potentiometer, $\pm 100\text{ fA}$				
Performance Depending on Gain Setting	Gain setting (V/A)	10 ⁴	10 ⁵	10 ⁶	10 ⁷	10 ⁸
	Upper cut-off frequency (-3 dB)*	400 Hz	400 Hz	400 Hz	400 Hz	150 Hz
	Rise/fall time (10 % - 90 %)*	0.8 ms	0.8 ms	0.8 ms	0.8 ms	2.3 ms
	Integrated input noise current (peak-peak)*	7 nA	7 nA	70 pA	70 pA	1.2 pA
	Spectral input noise current density ($\sqrt{\text{Hz}}$)	45 pA	45 pA	0.45 pA	0.45 pA	15 fA
	Measured at	10 Hz	10 Hz	10 Hz	10 Hz	10 Hz
	Gain drift ($^\circ\text{C}$)	0.01 %	0.01 %	0.01 %	0.01 %	0.01 %
	Max. input current (\pm full scale)	1 mA	0.1 mA	10 μA	1 μA	0.1 μA
	DC input impedance (\parallel 5 pF)	< 1 Ω	< 1 Ω	< 1 Ω	< 1 Ω	< 100 Ω
	Gain setting (continued) (V/A)	10 ⁹	10 ¹⁰	10 ¹¹	10 ¹²	10 ¹³
	Upper cut-off frequency (-3 dB)*	150 Hz	20 Hz	20 Hz	1 Hz	1 Hz
	Rise/fall time (10 % - 90 %)*	2.3 ms	17 ms	17 ms	350 ms	350 ms
	Integrated input noise current (peak-peak)*	1.2 pA	50 fA	50 fA	2 fA	2 fA
	Spectral input noise current density ($\sqrt{\text{Hz}}$)	15 fA	1.3 fA	1.3 fA	0.2 fA	0.2 fA
	Measured at	10 Hz	1 Hz	1 Hz	0.4 Hz	0.4 Hz
	Gain drift ($^\circ\text{C}$)	0.01 %	0.03 %	0.03 %	0.03 %	0.03 %
	Max. input current (\pm full scale)	10 nA	1 nA	0.1 nA	10 pA	1 pA
	DC input impedance (\parallel 5 pF)	< 100 Ω	< 10 k Ω	< 10 k Ω	< 1 M Ω	< 1 M Ω

* The values for upper cut-off frequency, rise/fall time and integrated input noise current stated in the table above are achieved with the low pass filter set to "Full BW / Fast" (full bandwidth/fast rise time). Lower peak-to-peak noise values can be achieved by setting the low pass filter to 0.7 Hz or 0.1 Hz. In that case the bandwidth will be lower and the signal rise / fall time will be longer though.

Variable Gain Sub Femto Ampere Current Amplifier

Specifications (continued)		
Output	Output voltage Output impedance Max. output current	± 10 V (load ≥ 100 k Ω) 50 Ω (terminate with ≥ 100 k Ω load for best performance) ± 30 mA
Adjustable Bias Voltage	General	An adjustable bias voltage is provided for directly biasing the device under test DUT (e.g. photodiode, high resistance semiconductor component). The bias voltage is connected to the inner conductor of the BNC input socket; the BNC-shield is always connected to analog ground. The bias voltage can be set either locally at the amplifier or through the remote interface. For measurements not requiring a bias voltage it can be fully disabled.
	Bias voltage range Bias current	± 10 V at inner conductor of BNC input socket max. ± 10 mA
Local Bias Adjustment	Bias switch setting Bias adjustment	set bias switch to position "Int." adjust bias voltage by bias potentiometer
Remote Bias Adjustment	Bias switch setting Bias adjustment	set bias switch to position "Ext." adjust bias by analog control voltage fed to pin 8 of Sub-D connector (referred to AGND pin 3)
	Input impedance of control pin 8 Bias control voltage range Bias control polarity Example:	200 k Ω ± 10 V at pin 8 (referred to AGND pin 3) inverting feeding a control voltage of +2 V to pin 8 of the Sub-D connector leads to -2 V bias voltage at the inner conductor of the BNC input socket referred to BNC shield (analog ground, AGND)
Bias Deactivation	Bias switch setting	set bias switch to position "Off"
Bias Monitor Output	Range Connector Output impedance	± 10 V, shows the adjusted bias voltage at the BNC input (inner conductor referred to AGND pin 3) pin 7 of Sub-D connector (referred to AGND pin 3) 50 Ω (terminate with ≥ 100 k Ω load for best performance)
Overload Indication	LED Overload output	lights when overload is detected non active: < 0.4 V @ 0 ... -1 mA, active: typ. 5 ... 5.1 V @ 0 ... 2 mA
Digital Control	Control input voltage range Control input current	LOW bit: -0.8 ... +1.2 V, HIGH bit: +2.3 ... +12 V 0 mA @ 0 V; 1.5 mA @ +5 V; 4.5 mA @ +12 V
Auxiliary Power Output	Voltage	± 12 VDC, stabilized, max. ± 20 mA (at Sub-D, may be used for supplying external devices up to ± 20 mA)
Power Supply	Supply voltage Supply current	± 15 V +70 mA / -15 mA typ. (depends on operating conditions, recommended power supply capability minimum ± 150 mA)
Case	Weight Material	320 g (0.74 lb.) AlMg4.5Mn, nickel-plated
Temperature Range	Storage Temperature Operating Temperature	-40 ... +85 $^{\circ}$ C 0 ... +50 $^{\circ}$ C

Variable Gain Sub Femto Ampere Current Amplifier

Absolute Maximum Ratings	Signal input voltage ± 15 V relative to bias Transient input voltage ± 2 kV (discharge from 1 nF source) Digital control input voltage -5 V / $+16$ V Bias control input voltage ± 12 V Power supply voltage ± 20 V
--------------------------	---

Connectors	Input BNC, isolated, jack (female) Output BNC, jack (female) Bias voltage output center pin of BNC input socket Power supply Lemo [®] series 1S, 3-pin fixed socket (mating plug type: FFA.1S.303.CLAC52) Pin 1: +15V Pin 2: -15V Pin 3: GND
------------	---

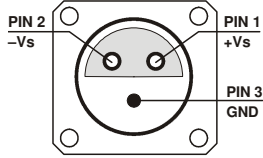

Control Port	Sub-D 25-pin, female, qual. class 2 Pin 1: +12V (stabilized power supply output) Pin 2: -12V (stabilized power supply output) Pin 3: AGND (analog ground) Pin 4: NC Pin 5: overload output (referred to AGND pin 3) Pin 6: signal output (connected to BNC output connector) Pin 7: bias voltage monitor output (referred to AGND pin 3) Pin 8: bias control voltage input (referred to AGND pin 3) Pin 9: DGND (ground for digital control pins 10 - 13) Pin 10: digital control input: gain, LSB Pin 11: digital control input: gain Pin 12: digital control input: gain Pin 13: digital control input: gain, MSB Pin 14 - 25: NC
--------------	---

Variable Gain Sub Femto Ampere Current Amplifier

Remote Control Operation	General	<p>Remote control input bits are opto-isolated. For remote control operation set the rotary gain switch to the "Remote" position and select the desired gain setting via a bit code at the digital inputs.</p> <p>Switch settings "0.1 Hz / Full BW / 0.7 Hz" and "Bias Ext. / Off / Int." are not remote controllable.</p>																																																									
	Gain Setting	<table style="width: 100%; border-collapse: collapse;"> <thead> <tr> <th style="text-align: left; border-bottom: 1px solid black;">Gain (V/A)</th> <th style="text-align: center; border-bottom: 1px solid black;">Pin 13 MSB</th> <th style="text-align: center; border-bottom: 1px solid black;">Pin 12</th> <th style="text-align: center; border-bottom: 1px solid black;">Pin 11</th> <th style="text-align: center; border-bottom: 1px solid black;">Pin 10 LSB</th> </tr> </thead> <tbody> <tr><td>10^4</td><td style="text-align: center;">LOW</td><td style="text-align: center;">LOW</td><td style="text-align: center;">LOW</td><td style="text-align: center;">LOW</td></tr> <tr><td>10^5</td><td style="text-align: center;">LOW</td><td style="text-align: center;">LOW</td><td style="text-align: center;">LOW</td><td style="text-align: center;">HIGH</td></tr> <tr><td>10^6</td><td style="text-align: center;">LOW</td><td style="text-align: center;">LOW</td><td style="text-align: center;">HIGH</td><td style="text-align: center;">LOW</td></tr> <tr><td>10^7</td><td style="text-align: center;">LOW</td><td style="text-align: center;">LOW</td><td style="text-align: center;">HIGH</td><td style="text-align: center;">HIGH</td></tr> <tr><td>10^8</td><td style="text-align: center;">LOW</td><td style="text-align: center;">HIGH</td><td style="text-align: center;">LOW</td><td style="text-align: center;">LOW</td></tr> <tr><td>10^9</td><td style="text-align: center;">LOW</td><td style="text-align: center;">HIGH</td><td style="text-align: center;">LOW</td><td style="text-align: center;">HIGH</td></tr> <tr><td>10^{10}</td><td style="text-align: center;">LOW</td><td style="text-align: center;">HIGH</td><td style="text-align: center;">HIGH</td><td style="text-align: center;">LOW</td></tr> <tr><td>10^{11}</td><td style="text-align: center;">LOW</td><td style="text-align: center;">HIGH</td><td style="text-align: center;">HIGH</td><td style="text-align: center;">HIGH</td></tr> <tr><td>10^{12}</td><td style="text-align: center;">HIGH</td><td style="text-align: center;">LOW</td><td style="text-align: center;">LOW</td><td style="text-align: center;">LOW</td></tr> <tr><td>10^{13}</td><td style="text-align: center;">HIGH</td><td style="text-align: center;">LOW</td><td style="text-align: center;">LOW</td><td style="text-align: center;">HIGH</td></tr> </tbody> </table>	Gain (V/A)	Pin 13 MSB	Pin 12	Pin 11	Pin 10 LSB	10^4	LOW	LOW	LOW	LOW	10^5	LOW	LOW	LOW	HIGH	10^6	LOW	LOW	HIGH	LOW	10^7	LOW	LOW	HIGH	HIGH	10^8	LOW	HIGH	LOW	LOW	10^9	LOW	HIGH	LOW	HIGH	10^{10}	LOW	HIGH	HIGH	LOW	10^{11}	LOW	HIGH	HIGH	HIGH	10^{12}	HIGH	LOW	LOW	LOW	10^{13}	HIGH	LOW	LOW	HIGH		
Gain (V/A)	Pin 13 MSB	Pin 12	Pin 11	Pin 10 LSB																																																							
10^4	LOW	LOW	LOW	LOW																																																							
10^5	LOW	LOW	LOW	HIGH																																																							
10^6	LOW	LOW	HIGH	LOW																																																							
10^7	LOW	LOW	HIGH	HIGH																																																							
10^8	LOW	HIGH	LOW	LOW																																																							
10^9	LOW	HIGH	LOW	HIGH																																																							
10^{10}	LOW	HIGH	HIGH	LOW																																																							
10^{11}	LOW	HIGH	HIGH	HIGH																																																							
10^{12}	HIGH	LOW	LOW	LOW																																																							
10^{13}	HIGH	LOW	LOW	HIGH																																																							

Variable Gain Sub Femto Ampere Current Amplifier

Typical Performance
Characteristics

Long term drift

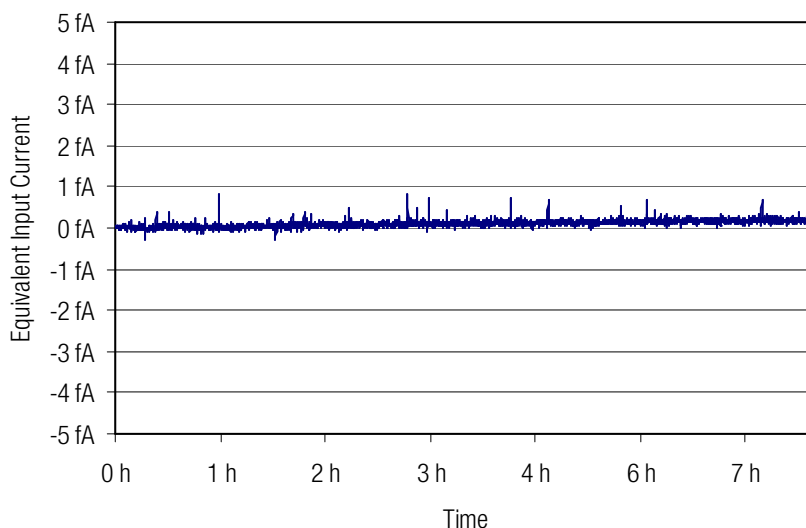

Short term drift

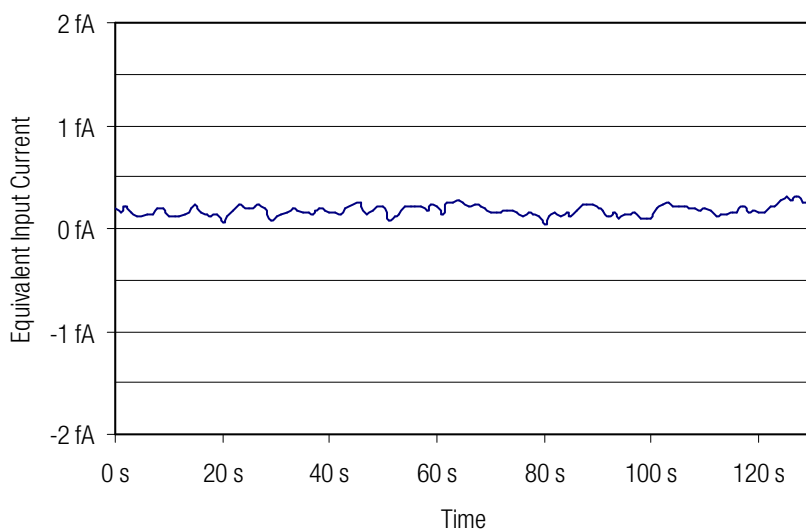

Both drift curves were recorded with shielded input in the gain setting 10^{12} V/A, filter setting 0.1 Hz (20 minutes warm-up before measurement).

Variable Gain Sub Femto Ampere Current Amplifier

Typical Performance
Characteristics

10 fA square wave

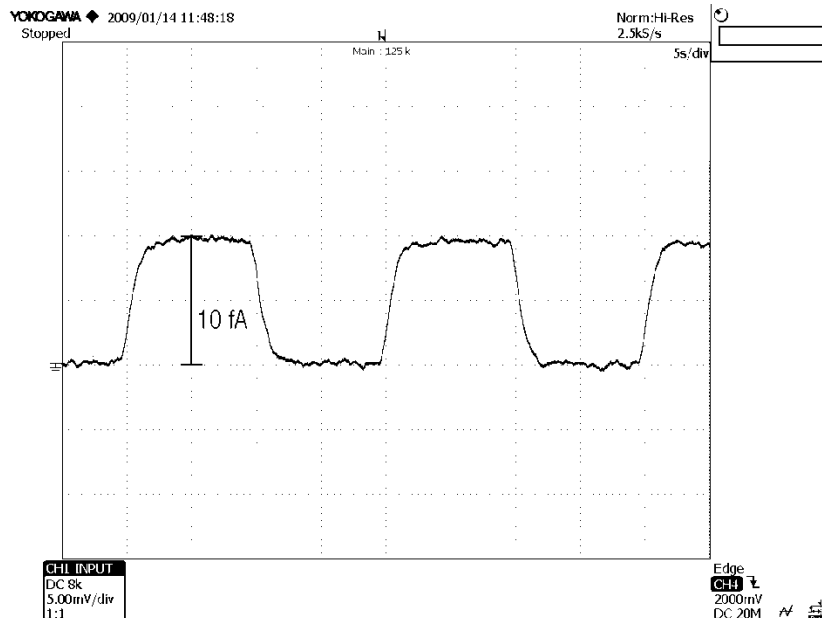

2 fA step curve

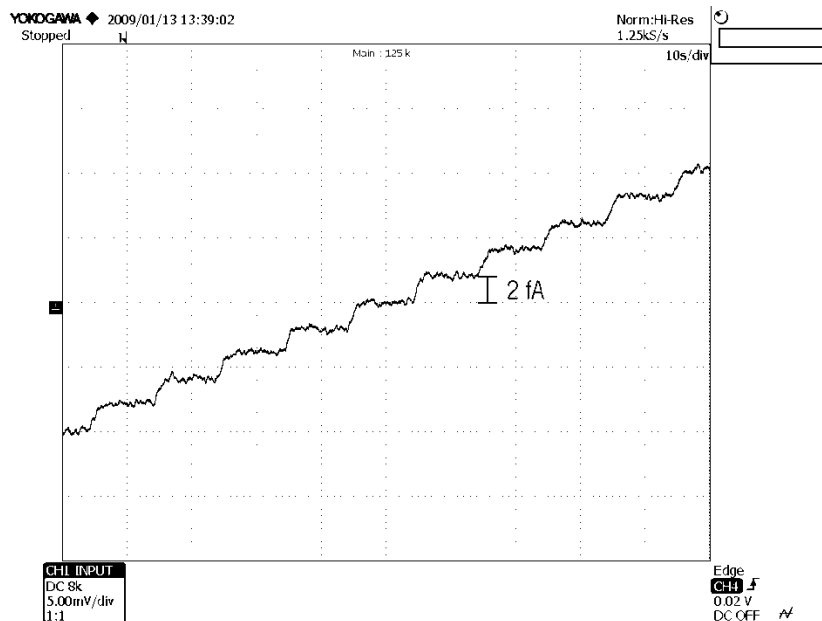

Both curves were recorded in the gain setting 10^{12} V/A, filter setting 0.7 Hz, no external averaging (20 minutes warm-up before measurement).

Variable Gain Sub Femto Ampere Current Amplifier

Typical Performance
Characteristics

0.5 fA step curve, no averaging

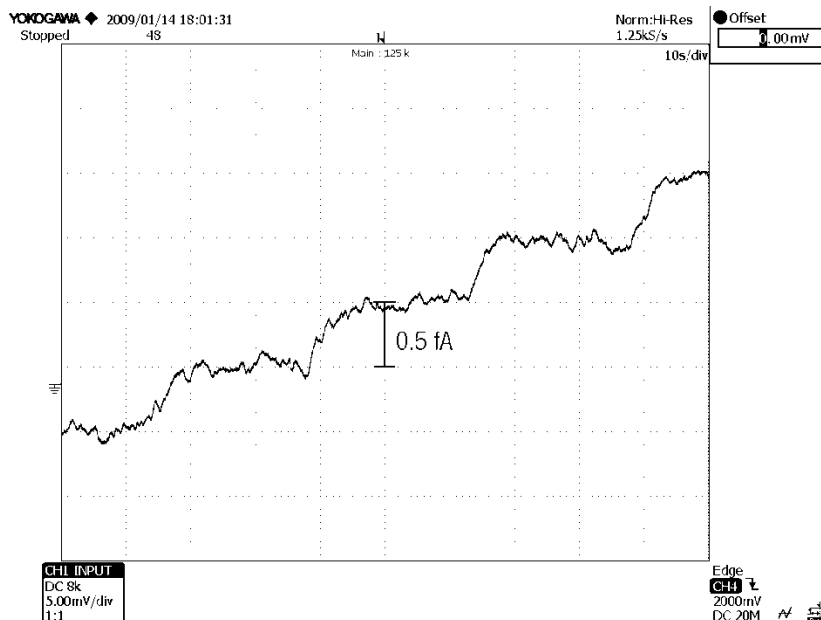

0.5 fA step curve, 4 times external averaging

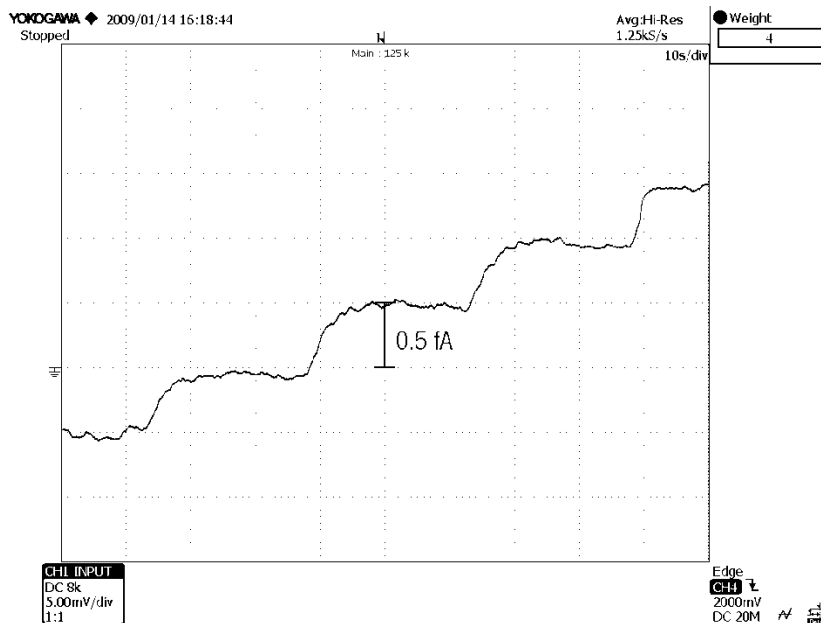

Both curves were recorded in the gain setting 10^{13} V/A, filter setting 0.1 Hz (20 minutes warm-up before measurement).

Variable Gain Sub Femto Ampere Current Amplifier

Dimensions

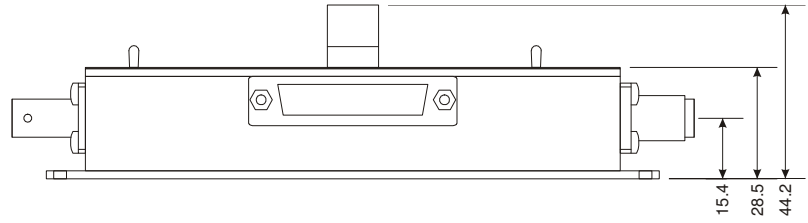
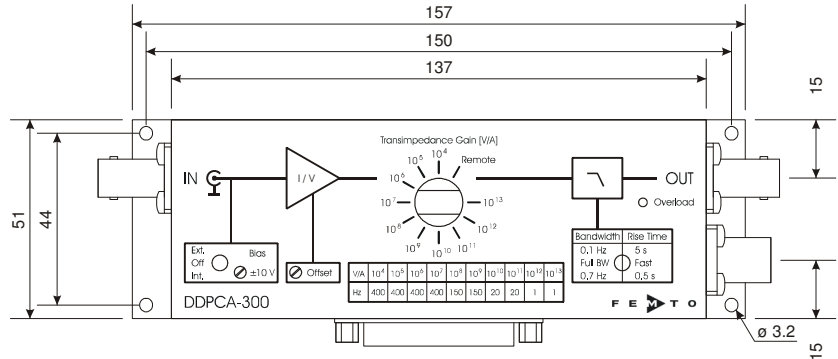

all measures in mm unless otherwise noted

DZ-DDPCA-300_R6

FEMTO Messtechnik GmbH
Klosterstr. 64
10179 Berlin · Germany
Phone: +49 30 280 4711-0
Fax: +49 30 280 4711-11
Email: info@femto.de
www.femto.de

Specifications are subject to change without notice. Information provided herein is believed to be accurate and reliable. However, no responsibility is assumed by FEMTO Messtechnik GmbH for its use, nor for any infringement of patents or other rights of third parties which may result from its use. No license is granted by implication or otherwise under any patent or patent rights of FEMTO Messtechnik GmbH. Product names mentioned may also be trademarks used here for identification purposes only.

© by FEMTO Messtechnik GmbH · Printed in Germany